

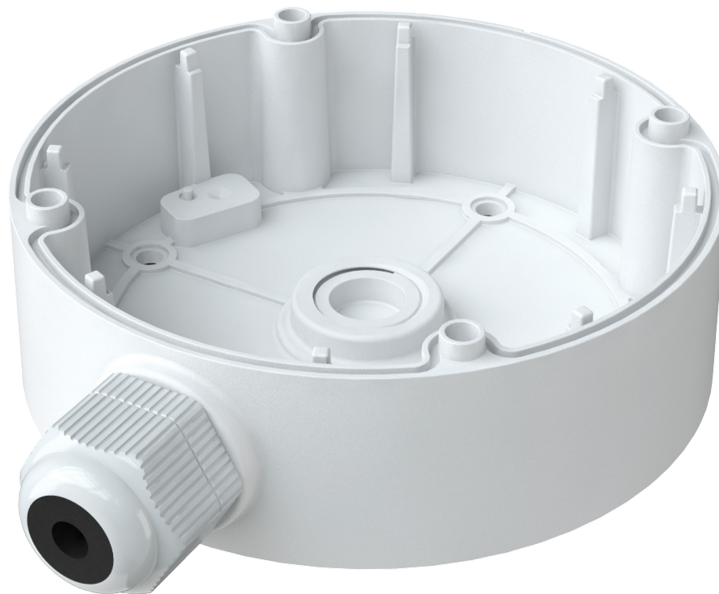





Junction box for fixed lens vandal dome cameras

DWC-MV9JUNC

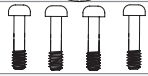

WHAT'S IN THE BOX

Mounting Screws and Anchors (PA4x25mm, head diameter 8mm)		x4
Waterproof Rings for Mounting Screws		x4
Mounting Template		x1
Camera Mounting screws (PM4x16, head diameter 8mm)		x4
Cable Gland Connector		x1

NOTE: Download all your support materials and tools in one place.

1. Go to: <http://www.digital-watchdog.com/resources>
2. Search your product by entering the part number in the **'Search by Product'** search bar. Results for applicable part numbers will populate automatically based on the part number you enter.
3. Click **'Search'**. All supported materials, including manuals and quick start guide (QSGs) will appear in the results.



INSTALLATION

- 1 Using the mounting template or the junction box itself, mark and drill the necessary holes on the mounting surface.
- 2 Secure the junction box to the mounting surface using the screws and anchors included.
- 3 To mount the camera to the mounting accessory, remove the dome from the camera base using the wrench included with the camera.

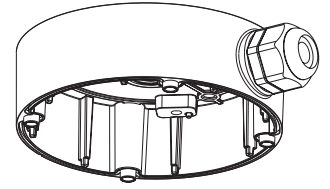

NOTE: Do not touch the lens when handling the camera.

- 4 Pass wires through and make all necessary connections.
- 5 Secure the camera to the mounting bracket using the included screws.
- 6 Adjust the camera lens position and angle and complete the installation by placing the dome cover on the camera. Secure the dome cover to the camera base using the screws included with the camera. See the camera's QSG for more information.

