





Wall mount bracket for white IP PTZ cameras

DWC-P230CMW



WHAT'S IN THE BOX

Screw and Plastic Anchors		4pcs	Quick Installation Guide		1
Hexagonal Wrench		1	Mounting Template		1

NOTE: Download all your support materials and tools in one place

1. Go to: <http://www.digital-watchdog.com/resources>
2. Search your product by entering the part number in the **'Search by Product'** search bar. Results for applicable part numbers will populate automatically based on the part number you enter.
3. Click **'Search'**. All supported materials, including manuals and quick start guide (QSGs) will appear in the results.



INSTALLATION

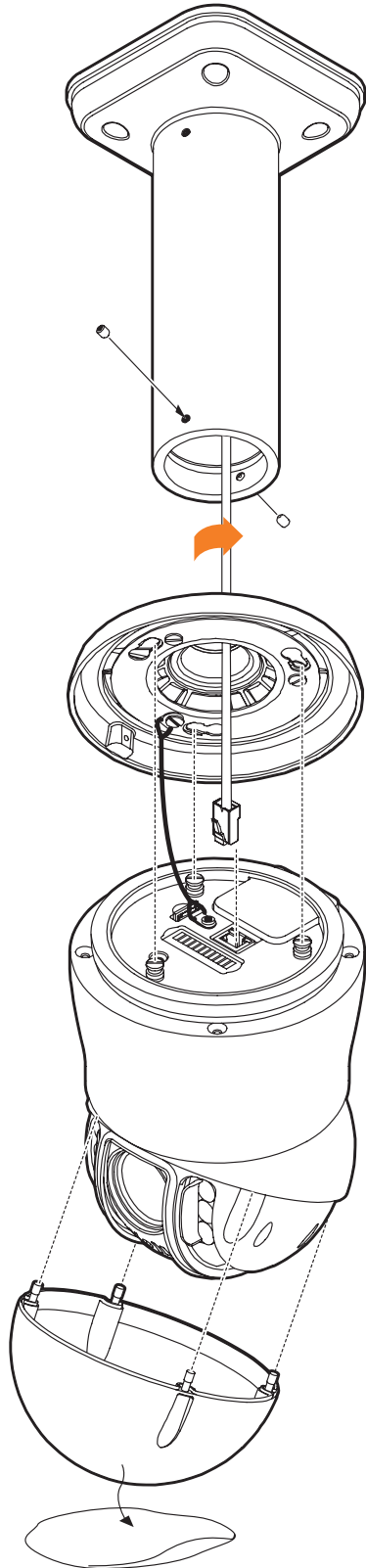

1. Using the mounting template or the accessory itself, mark and drill the necessary holes in the mounting surface.
2. Use the included screws and anchors to secure the ceiling mount to the mounting surface.
3. Pass wires through the mounting bracket.
4. Connect the camera's base into the ceiling mount's neck, and secure using the screws on the side of the neck.
5. Open the camera's base by rotating the base clockwise to the unlock position. Make sure the camera's safety wire is connected between the camera base and the camera module.

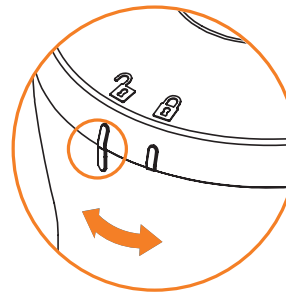

UNLOCK

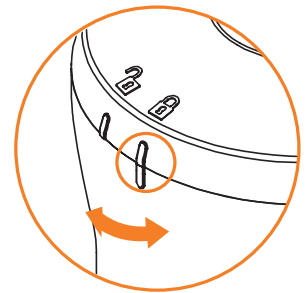

LOCK

6. Connect all wires to the camera. Please refer to the camera's QSG for cable management.
7. Attach the camera's body to the base by rotating the base counter-clockwise to the lock position.
8. Place and secure the camera dome cover using the screws at the base of the dome.
9. Remove the protection film when the installation is complete.